



# MAMMOTH STAINLESS

OPERATOR MANUAL  
Heavy Duty Industrial Wet & Dry Vacuum Cleaner



Please read this manual before using the MAMMOTH STAINLESS

**CONTENTS**

Specification

Installation, Use, Maintenance and safety instructions

Parts Diagrams

Maintenance log

**TECHNICAL DATA:****Industrial Specification - MAMMOTH STAINLESS**

	<b>MAMMOTH110-STAINLESS</b>	<b>MAMMOTH240-STAINLESS</b>
NOISE - DB - TESTED FROM 2 METERS in warehouse environment	78	86
NOISE - DB - TESTED FROM 3 METERS- in warehouse environment	75	85
TANK CAPACITY - (LITRES)	80	80
WET CAPACITY - (LITRES)	54	54
DRY CAPACITY - (LITRES)	65	65
HOSE ID - MM	38	38
AIR FLOW	60 CFM	86 CFM
AIR FLOW L/SEC (PER MOTOR)	28 CFM	41 CFM
AIR VELOCITY (M/SEC)	25	36
PRODUCT WEIGHT (without accessories) kg	27	27
PACKED WEIGHT (including accessories) - kg	33	33
DIMENSIONS (L x W x H mm)	640 x 620 x 1010	640 x 620 x 1010
PACKAGING (L x W x H cm)	660 x 640 x 1060	660 x 640 x 1060

## INTRODUCTION

Thank you for purchasing V-TUF product.

V-TUF is focused on research and development to make sure you are fully satisfied with our products. Please read this manual carefully and follow the instructions to ensure you get the best performance from this machine.

Congratulations on your choice.

## IMPORTANT POINTS TO NOTE AT ALL TIMES!

1. Always ensure you are using the correct combination of filters for the task you are doing. (See page 4.)
2. If you experience vacuum loss, please clean the filters, check & clear the blockage in the suction line, and blast the vacuum head vents with air, so you have maximum suction power. (See page 4 & 5.)
3. Do not leave the vacuum motors running if there is loss of suction, as they can overheat.
4. After every hour of use especially when vacuuming dry dust, blast the filters clear with an airline and blast the vent areas in the vacuum head to clear any build-up of dust.
5. Never use standard extension cords on the 240 volt machines, as these are not sufficient for three motor operation and can burn the motors out. Only use the 'Motor saver' extension cords.
6. Before use operators must be provided with information, instruction and training for the use of the machine and the substances for which it is to be used, including the method of operation, cleaning and maintenance and disposal of the material being collected.
7. This manual has been included as an integral part of the appliance and should be carefully read through BEFORE using the machine.
8. Take the appliance out of its packaging and make sure it is in perfect condition, including accessories and any optional extras you have purchased from the V-TUF range.
9. Make sure that the electrical data of the appliance, shown on the label, corresponds to those of the mains supply.
10. The appliance must only be used with V-TUF accessories and spare parts.
11. The manufacturer disclaims all liability for injury to persons and animals and damage to things due to the irresponsible use of the appliance and to the use of non-original accessories and spare parts.
12. The repair and/or replacement of the various component parts, especially electrical parts, must be done by competent, trained personnel.

## GENERAL INFORMATION

1. This manual has been included as an integral part of the appliance and should be carefully read through before using the machine.
2. Take the appliance out of its packaging and make sure it is in perfect condition, including accessories and any optional extras you have purchased from the V-TUF range.
3. Make sure that the electrical data of the appliance, shown on the label, corresponds to those of the mains supply.
4. The appliance must only be used with V-TUF accessories and spare parts as these ensure safe and perfect operation.
5. The manufacturer disclaims all liability for injury to persons and animals and damage to things due to the irresponsible use of the appliance and to the use of non-original accessories and spare parts.
6. The repair and/or replacement of the various component parts, especially electrical parts, must be done by skilled personnel.
7. Before use operators must be provided with information, instruction and training for the use of the machine and the substances for which it is to be used, including the method of operation, cleaning and maintenance and disposal of the material being collected.

## INSTALLATION

1. Check the position of the filter and the clips that fasten the head to the tank. Incorrect filter positioning can cause serious damage to the machine.
2. Fit the hose to the vacuum connector; fit the required accessory to the end of the hose. In the case of extractor models fit the pipe on the connector provided on the head and fit the required accessory to the end of the pipe.
3. Connect the power cable of the appliance to the power socket ensure that the switches are "0" (OFF POSITION).



For general Non-Hazardous DRY material vacuuming and a bit of WET material vacuuming (typical in auto valeting), ensure the Aqua-dry and the Foam filter is in place.

5. To vacuum liquids, empty the dust from the container, remove the main Aqua-Dry basket filter and ensure the foam filter is fitted. After the vacuum has been used for wet use ensure the tank and foam filter is dry before vacuuming dry non-hazardous material.



Important: If you are vacuuming a lot of dry non-hazardous material, we advise you to fit the optional High Efficiency FILTER - VTVS7026L, fits over the main basket filter, as shown in the image. This filter must be used for grain store cleaning on farms or in industry where there is fine dust or if you notice your machine losing suction quickly.

6. The noise level is below 86 dB(A)

## OPERATION INSTRUCTIONS

1. Ensure that there is sufficient ventilation for the machine and the operator
2. Make sure the machine on a sound and stable surface.
3. Ensure the machine is switched to the off position, connect to the correct and sufficient power source, switch machine on, use according to the guidelines and turn machine off, empty and clean after operation.

## IMPORTANT

1. The wet and dry machines feature a floating valve that interrupts the vacuum when the tank is full of liquid. When this occurs, turn the machine off and empty the entire contents of the tank.
2. Do not use your machine if it is not functioning correctly. Regularly inspect electrical leads and connections, filters and listen for unusual noises. If in doubt, contact your nearest service centre for advice.

## MAINTENANCE

1. The filter element can be vacuum cleaned OR washed with water. Ensure that it is completely dry before the operation.
2. Replace the vacuum filter if it is
3. Check and free the blocked parts (vacuum pipes, connector, brushes, etc.) from any deposited materials.
4. If necessary, clean the tank and in any case, never leave dust or liquid residues in the tank for long periods of time.
5. Ensure all residue material buildup is cleared from the air passages within the vacuum cleaner.

## IMPORTANT INFORMATION

Never use the machine if you are unsure or become uncertain due to any faults of any kind, including those not mentioned in this manual.

Ensure that the machine has an up to date electrical and functional safety test and that nothing has been moved or replaced since the test was carried out.





### Safety Instructions

These instructions are for the user's safety, and all users of the V-TUF cleaning equipment should ensure to have read this literature before using the machine.











- If any part of the appliance becomes damaged or fractured, it must be replaced by a V-TUF engineer.
- This machine shall be used only by trained, competent and experienced operators. Operators should observe any safety regulations appropriate to the materials being handled.
- Do not run over the cable.
- Do not use in the presence of flammable gasses.
- Do not use with a damaged cable.
- This machine should be kept out of the reach of children and pets at all times.
- Do not clean up any hot material, e.g. ash.
- Always turn off the machine, and then unplug it, before you service the machine. Do NOT use this machine without the filters, as this is a health hazard and will damage and contaminate the internals of the vacuum cleaner.
- All repairs on V-TUF products should be done by an authorised service representative.
- If the machine shuts down, be sure to turn off the machine and unplug it before troubleshooting.
- Always turn off and unplug the machine when it is not in use. If any part of the appliance becomes damaged or fractured, it must be replaced with genuine V-TUF replacement parts only.
- The operator must turn the machine off immediately if it makes a funny noise, is running hotter than normal or is emitting material, particulates or smoke from the motors.

## SAFETY PRECAUTIONS

### Caution: what to do

1. All power conduction parts must be protected against water. SHORT-CIRCUIT RISK.  
2. All services or maintenance performed on the appliance must always be done with the plug disconnected from the power supply.  
3. Operation with a residual current circuit breaker provides extra protection for the operator (In=30 mA).
4. Only ever use the appliance for the purposes for which it has been designed and manufactured. ACCIDENT RISK. 
5. If vacuum exhaust starts emitting material, turn off immediately and check the waste level and ensure all correct filtration is present.
6. Only use the accessories provided with the machine
7. In the case of extractor models, only use detergents compatible with vacuum and pipe covering materials.
8. Ensure that the machine has an up to date electrical and functional safety test and that nothing has been moved or replaced since the test was carried out.

### Caution: what not to do

1. Do not leave the machine running and unguarded nor within reach of children, animals or persons that are not responsible for their own actions.  
ACCIDENT RISK. 
2. Do not vacuum inflammable combustion substance (e.g.: hot ashes), explosive and toxic substances, electrostatic or substances that are dangerous for health.  
EXPLOSION OR POISONING HAZARD   
3. Do not rest the vacuum inlet on or move this close to delicate parts of the body (eyes,   ears, mouth, etc.). ACCIDENT RISK.
4. Do not touch the plug and/or socket with wet hands. ELECTRIC SHOCK RISK   
5. Do not soak the appliance or spray it with liquid substances. SHORT-CIRCUIT.
6. Do not pull or lift the appliance using the power cable. SHORT-CIRCUIT RISK.  

## Transport and handling

### ATTENTION

- Ensure that the vacuum cleaner is empty and clean.
- Ensure that the head and accessories are properly secured.
- Ensure that the vacuum cleaners is transported in the upright position.
- Ensure that the vacuum cleaner and accessories are transported in the appropriate manner relating to the type of material being handled.

## BEFORE FIRST USE

### Vacuum assembly and testing

Before using the device, check that:

No foreign elements are present within the container.

Ensure that the head is fastened down with the head clips. This guarantees an air-tight seal. The hose is correctly connected to the tank.

The machine is connected to the correct electrical supply with the switch in the 0 (OFF) position.

### Initial working phase check

Before beginning to vacuum, check that the filters fit properly within the device and that they are positioned correctly.

## USE OF THE DEVICE

ATTENTION The vacuum cleaner must not be used for hazardous dusts including flammable and/or explosive material.



ATTENTION

The dust collection bag must not be filled past  $\frac{3}{4}$  of their capacities. Check periodically during use. Do not vacuum liquids or particularly humid substances while the bag filters are installed.

## END OF WORK ACTIVITIES

Must be carried out in a suitable, controlled area with the relevant PPE and methodology being used.

Disconnect the device's power supply by removing its electrical plug from the outlet.

Empty the waste container and dispose of the material according to the relevant regulations appropriate to the materials being handled.

Store the vacuum in a safe place where it cannot be accessed by unauthorised personnel.

Only use genuine V-TUF replacements on the appliance. V-TUF will not accept responsibility for damage to the machine or to the user due to insufficient levels of filtration for the application. The machine must only be used with the accessories provided.

## Accessories





## MAMMOTH STAINLESS

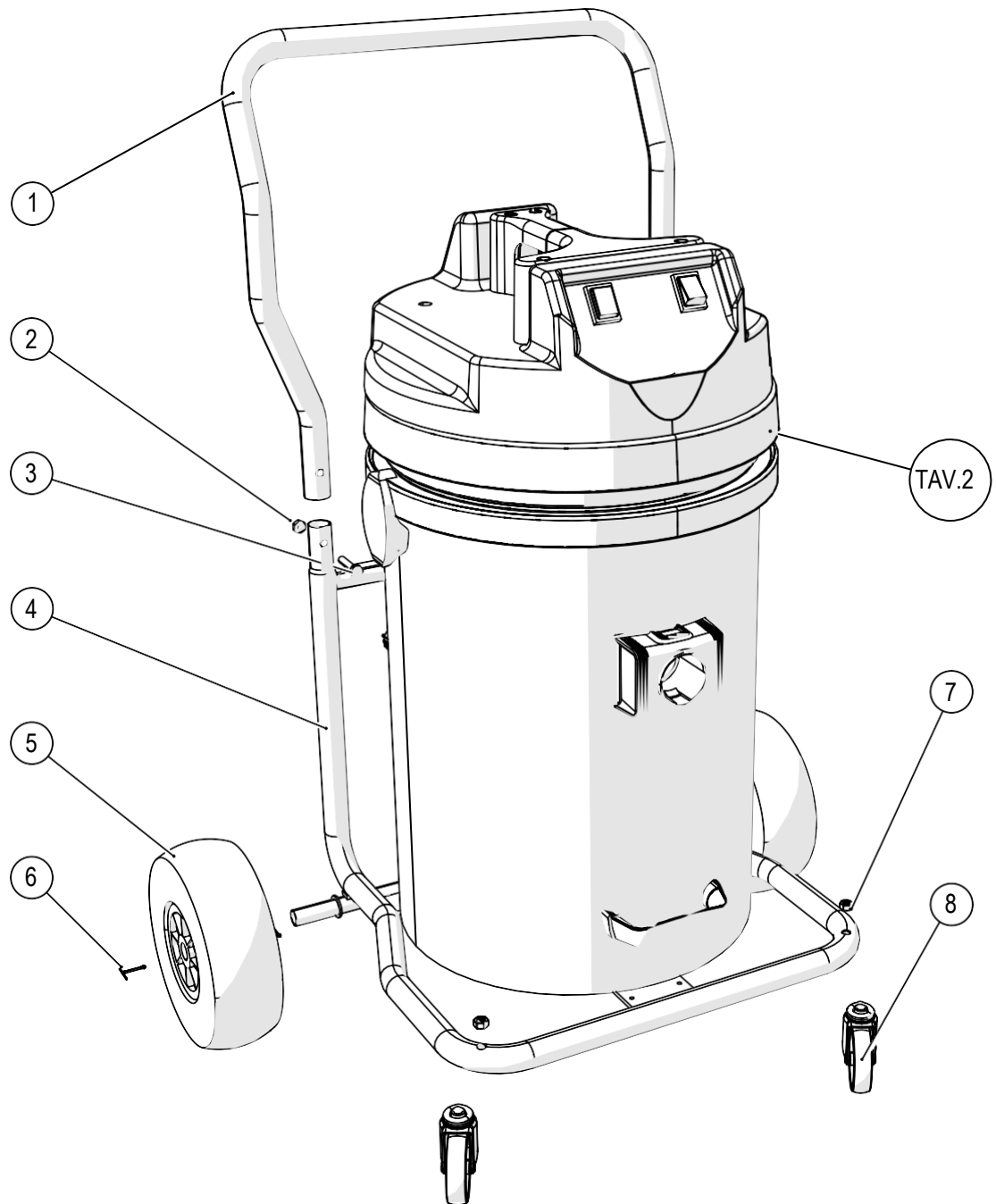

## MAMMOTH STAINLESS

### METAL TROLLEY

Pos.	Cod.	Q.ty	Description
1	VTVS8150	1	METAL TROLLEY ( PART A )
2	VTVS8151	2	CLOSED LOCK NUT M10
3	VTVS8152	2	HEXAGONAL HEAD METRIC SCREW M10X40
4	VTVS8159	1	METAL TROLLEY ( PART B )
5	VTVS0245T	2	WHEEL Ø260MM
6	VTVS8154	2	STAINLESS STEEL PIN Ø29X40MM
7	VTVS8151	2	CLOSED LOCK NUT M10
8	VTVS023MST	2	WHEEL Ø100MM

## MAMMOTH STAINLESS

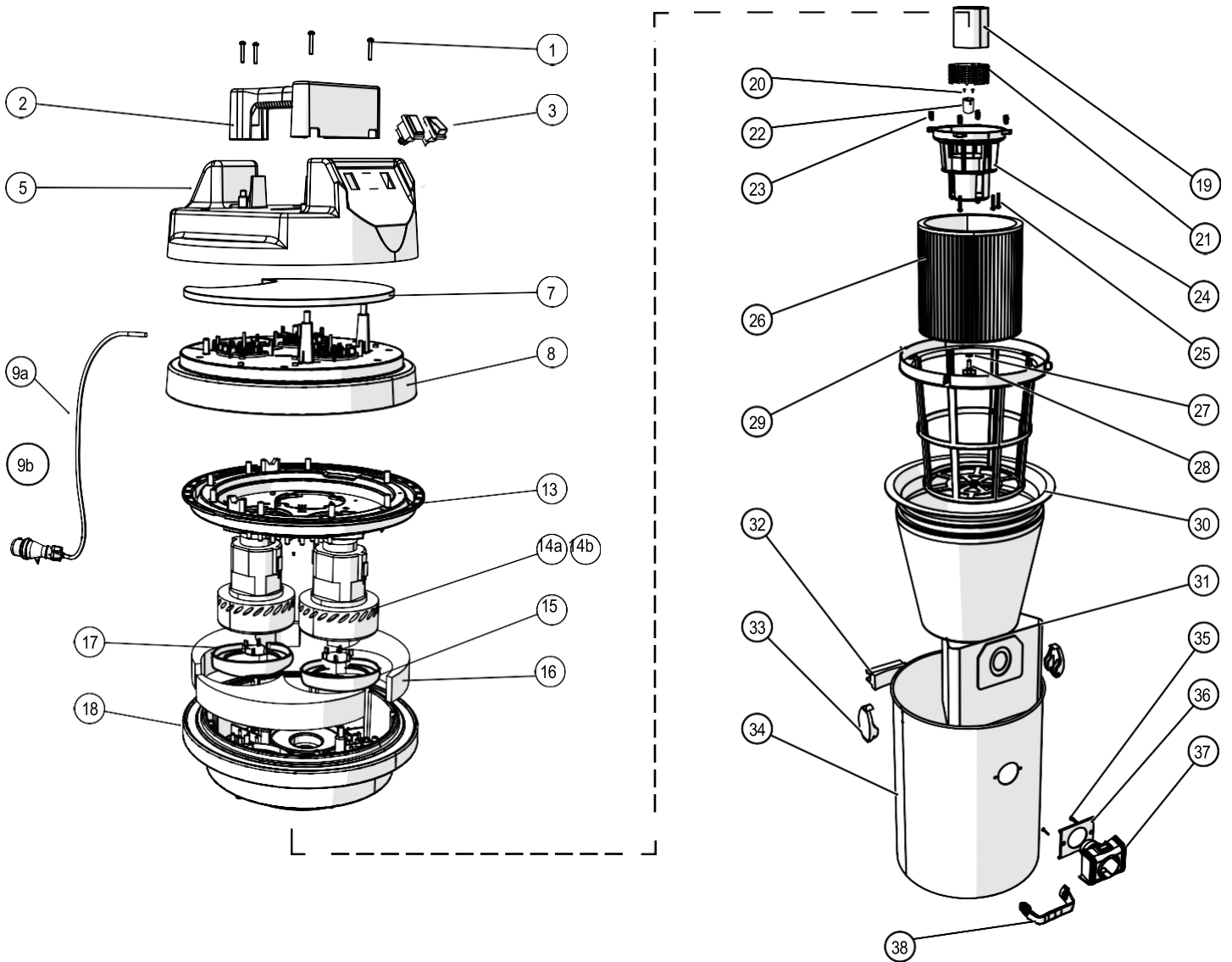

\*optional extras – Not included with the basic machine

Pos.	Cod.	Q.ty	Description
1	VTVS7513	4	SELF TIPPING SCREW 5X30 ZN
2	VTVS8100	1	HANDLE E.2 L=229MM
3	VTVS7422Y	2	RED LIGHT SWITCH 2P
5	VTVS8102	1	BLACK COVER Ø440 WITH 2 HOLES
7	VTVS8104	1	FOAM NOISE Ø370 E.2
8	VTVS8105	1	BLACK MOTOR COVER Ø452
9a 9b	I10. 1505C- 110V Cord + Plug I10. 1605C- 240V Cord + Plug	1	POWER CORD H05 2X1,5MMQ 110V
13	VTVS8108	1	BLACK MOTOR HOLDER Ø444
14	a. VTVS 7826 - 110V Motor b. VTVS 7825 - 240V Motor	2	DOUBLE STAGE MOTOR
15	VTVS8109	2	"L"GASKET S/F H=8
16	VTVS8110	3	SOUND ASSORBENT TRIANGLE
17	VTVS8111	2	AUTOMATIC VALVE Ø50
18	VTVS8112	1	YELLOW MOTOR BASE Ø452 WITH HOLE FO VBR
19	VTVS8113	1	FLOAT Ø80
20	VTVS8114	2	SELF TIPPING SCREW 2.9X19 ZB
21	VTVS8115	1	METAL GRID Ø92MM H54MM
22	VTVS8116	1	VIBRATOR SPACER H30MM
23	VTVS8117	4	SPRING H12MM
24	VTVS8118	1	FLOAT SUPPORTING Ø168
25	VTVS7512	4	SELF TIPPING SCREW5X25 TC ZN
26	VTVS8022	1	HEPA CARTRIDGE FILTER Ø250 H178
27	VTVS8119	1	GASKET NBR 15X7, 8X2 MM (optional extras)*
28	VTVS8120	1	CARTRIDGE WINGNUT M8X20 (optional extras)*
29	VTVS8121	1	FILTER BASKET Ø252
30	VTVS8021	1	POLYESTER FILTER WITH RING Ø44 (optional extras)*
31	VTVS055	5	POLYESTER BAG (optional extras)*
32	VTVS8122	1	TANK ROLLO HINGE Ø25
33	VTVS7491	2	COMPLETE SPRING HOOK BLACK
34	VTVS8124	1	STAINLESS STEEL TANK H=580
35	VTVS7512	2	SELF TIPPING SCREW 5X25 TCZN
36	VTVS7164	1	GASKET INLET Ø48
37	VTVS7165m	1	INLET Ø48
38	VTVS8125	1	COMPLETE HANDLE 120MM



**V-TUF<sup>®</sup>**

[www.V-TUF.COM](http://www.V-TUF.COM)