

V-TUF

TORRENT 2

VTUF110B (110 volt)

VTUF240B (240 volt)

INDUSTRIAL MOBILE BOWSER
COLD WATER PRESURE WASHER



User Operators Manual



English
Operators
Manual

CE

© V-TUF

Contents

Page No	Description / Contents
3-5	Important safety Instructions
6-8	Safety Features & Security Norms
9	Technical Data
10	Identification Data
11-12	Use the of machine
13-14	Transport & Lifting
15	Cleaning Applications
16-18	Troubleshooting
19	Accessories & Part List

Important Safety Instructions

This book has important information for the use and safe operation of this machine.

Read and understand all warnings before you start working.

IDENTIFICATION LABEL

Before using this machine, make sure that it is provided with the identification Label. In case the identification Label is missing, do not use the machine and consult your dealer immediately.

The Identification Label with the technical specifications is fixed to the Chassis on the rear of the enclosure inside the unit.



WHEN USING THIS MACHINE, PLEASE FOLLOW THESE BASIC PRECAUTIONS

1. Read and understand all the instructions before using the machine.
2. Know how to stop the machine and release pressure quickly, be familiar with all the controls.
3. The jet must not be directed at persons, animals, live electrical equipment or the appliance itself.
4. Always make sure you are using the correct fuel in the engine BEFORE filling tank.
5. Do not direct the jet against yourself or others in order to clean clothes or foot-wear.
6. Switch off machine before carrying out user maintenance.
7. High pressure cleaners must not be used by children or untrained personnel.
8. High pressure hoses, fittings and couplings are important for the safety of the appliance. Use only hoses, fittings and couplings recommended by V-TUF.
9. Always wear suitable eye, face and body protection.
10. Do not operate the machine when fatigued or under the influence of alcohol or drugs.
11. Keep operating area clear of all persons.
12. Do not overreach or stand on any unstable ground, keep good footing and balance at all times.
13. Follow the maintenance instructions specified in the manual.
14. Do not use in an enclosed or unventilated area.
15. To prevent fire hazard, do not use with or near inflammable substances such as: petrol, solvents or thinners.



This manual should be considered a permanent part of the machine and should remain with it if ownership is transferred.

Save These Instructions in a Safe Place

General Points

Instruction Manual

Please check that the manual is in good condition and that each of the pages are clearly legible. Should the manual be damaged, or missing any pages, please return it immediately to your re-seller who will provide you with a replacement copy. Alternatively, you can download this document as a pdf from the website at v-tuf.com and search for this GB110 Industrial Pressure Washer.

Conservation of the Manual

This manual should be retained for the full working life of the machine. In case of loss or damage, please request a copy from V-TUF, quoting type of machine, matriculation number and the year of manufacture.

Trial before shipment

The machine has been tested at the manufacturer's factory by a V-TUF technician to check that all of the components are functioning correctly according to the machine's specifications.

Guarantee Terms

The machine is under guarantee according to agreed contractual terms which constitute an integral part of the order or the rules in force, in all cases, for a maximum period equivalent to twelve (12) months from the date of dispatch from the factory. The guarantee covers exclusively breakages which could be due to defective mechanics or assembly. The guarantee does not cover parts subject to wear and tear. The guarantee is considered forfeit in the following cases:

1. Improper use of the machine, failure to observe the rules of use,
2. Use of non-original parts, those not sold directly by the manufacturer or an authorised re-seller,
3. Modifications made to the machine, or repairs made to the machine by anyone not specifically authorised by the manufacturer or by the re-seller.

Packaging

The packing materials and any parts replaced during maintenance should be collected and sent to a specialist waste disposal firm (wood, plastic, metal etc.) and not left within the reach of children or animals.

Delivery

The transport will be carried out by qualified companies, in respect to regulations in force and legislation relative to weight and length. The merchandise travels under the full responsibility of the transporter and the user; in the event of an accident, or late delivery, the manufacturer accepts no liability.

Checks

Upon receipt of the goods, check the condition that they are in. Should they appear damaged, avoid any type of installation and immediately advise the transporter and the supplier.

To ascertain the condition of the parcel, proceed to unpack the goods and check that the delivery is complete (check the correspondence with the delivery note), ascertain whether the machine has arrived in generally good condition, free of breakages or dents. In the event of missing or damaged items, immediately advise the re-seller and / or the manufacturer after having reported these when signing the transporter's delivery note.

Personal identifying data

An exact description of the model, serial number and installed accessories will aid a quick and efficient response on the part of the manufacturer or help centre. Always provide the type, model of machine and its serial number each time you contact the help centre.

To help you remember, we suggest that you place the relevant machine details in the panel below:

Model	Serial N°
Year of manufacture	Type of pump
Type of engine	

Prior to use, please carefully read the instructions, paying particular attention to "IMPORTANT RECOMMENDATIONS", "SECURITY NORMS" and "PRECAUTIONS".

It is forbidden to remove or tamper with the protective parts of the machine.

It is forbidden to use inflammable, explosive or toxic substances.

It is obligatory to use appropriate protective equipment.

It is obligatory to keep the machine clean and in good working order, in particular the controls, the connections and the technical data panel.

For your safety, and that of those around you, and for the continued working of the machine, do not use parts other than those prescribed by the constructor.

Before using the high pressure cleaner, always try to ensure that any potential hazardous conditions have been removed or eliminated from the area of usage.

The high pressure cleaner should be used with clean water. Unfiltered water and/or corrosive chemicals will cause damage to the machine.

IMPORTANT RECOMMENDATIONS

The ordinary use of this machine does not require particularly specialised training, as long as the user has sufficient competence and training to carry it out, knowledge of this manual and is aware of general safety procedures.

Follow the instructions with great care for your safety and that of others, to safeguard your machine and protect the environment.

SECURITY NORMS

FOUR SYMBOLS TO REMEMBER



General danger



Ranger of severe damage to the machine



Danger to people



Safeguarding the environment

Your machine is supplied with electronic apparatus, the use of which requires the observation of the following safety criteria.



When using the machine outdoors, do not use when it is raining



Do not attempt any kind of maintenance whilst the plug is connected to any sort of power supply.



Take care not to spray the machine with the water jet as this could lead to short-circuit



Should you need to use an extension lead with the power supply, make sure that the connection between the extension lead and the power lead is secure and stable and conforms to standard safety norms. The plug and the socket should be waterproof.



Keep the machine out of reach of children or unauthorised personnel.



It is strictly forbidden for the user to operate the machine in any way in bare feet.



Do not use the machine if any of its components are defective.



Do not use the machine if there are people in your way.



Do not direct the water flow near sources of electricity.



Do not place your hands ahead of the lance; high pressure nozzles can be extremely dangerous when used inappropriately.



If the machine should be used in service stations, supply stations or other potentially dangerous locations, please ensure that the appropriate safety procedures are observed.



Do not touch the engine, the chimney the boiler or other internal parts when the machine is on, or immediately after it has been turned off as you may risk burning or scalding.



Should you need to clean the engine, this procedure should be carried out in places where, to safeguard the environment, an adequate oil separator is installed.



Re-filling of petrol should only be undertaken when the machine is turned off



Do not use combustible materials other than those advised by the constructor.



Once you have finished working, and after the machine has stopped, release the residual pressure in the tube and pump by squeezing the pistol lever.



It is strongly forbidden to carry out any operation with the machine if you are not wearing the appropriate safety equipment (protective glasses, gloves, overalls etc) as per established safety norms.



During winter, and in the event of frost, it is advisable to use anti-freeze or to empty out the water from the internal circuits by closing the tap from the water supply and activating the machine until all of the water is expelled.



Should the machine remain inactive for extended periods of time, it is possible that calcium deposits can form in the valves which can then cause problems when trying to re-start the machine. Should this happen, pay particular attention to any strange or unexpected noises emanating from the machine, in which case you should consult your local technical services.

IMPROPER USE

By improper use, we mean using the machine for uses which it was not specifically designed for, such as:

- Washing of objects or vehicles which have come into contact with inflammable or noxious dust, gas or liquids, or substances which can cause dangerous reactions when in contact with water.
- Use of the machine in places where there is a danger of explosions, or a significant risk of fire.
- Use of the machine for the cleaning of animals, of any size.
- Use of the machine by anyone under the age of 16 years.
- Use of the machine in the rain or during thunderstorms.
- Use of the machine for the washing of any equipment supplied by an electric current.
- Use of the machine by anyone unauthorised personnel, or anyone untrained to do so.

ERRONEOUS USE

By erroneous use, we mean the use of our machine without respect for the guidelines contained in the instruction and maintenance manual. Lack of respect for these guidelines can represent a risk of injury to both the operator and those persons nearby as well as a risk of serious damage to the machine itself.

Erroneous use, therefore, can constitute: unsecured connections (including those of accessories supplied as optional extras), not using original spare parts, repairs undertaken by unauthorised or unqualified personnel, use of the machine for purposes it was not designed for (see improper use), lack of proper maintenance and the high pressure tube to drag or haul the machine around.

PRECAUTIONS

Before activating the high pressure cleaner, make certain that the water supply is correct (min. 1 Bar – Max 8 Bar); dry use can provoke serious damage to the machine's waterproofing systems.

To safeguard the security of the operator and of the machine, avoid making modifications to the machine without the written consent of the manufacturer.

If you notice any damage to the machine, refrain from any and all work with the machine, and immediately inform the re-seller or an authorised technician.

During use, avoid covering the machine: if you consider it necessary to protect the machine, do it in such a way as to allow air to circulate freely in order to cool the engine.

In the event of a long pause / break during work / using the machine (more than 15 minutes), turn off the machine and release the residual pressure.

The maintenance of this machine requires the use of a qualified person who, as well as having knowledge of this instruction manual, should be equally familiar with general safety guidelines as well as those measures specific to this machine.

For matters of repair, maintenance and tuning, we always recommend that you refer to a re-seller or authorised technician.

ATTENTION:

Never under-estimate these warnings, use of the machine in an inappropriate manner, can lead to serious damage and injury to the operator and any surrounding personal. Don't take risks!

ATTENTION:

The manufacturer cannot be held responsible for any eventual damage or injury to people, animals or property resulting from improper or unreasonable use, or usage in any way not conforming to the instructions contained in this manual.

TECHNICAL DATA: Industrial Specification

TORRENT 2 – VTUF240B (240 volt)

TORRENT 2 VTUF110B (110 volt)

PRESSURE (PSI)	100BAR (1450PSI) Max
FLOW(L/MIN)	12
PUMP TYPE	XHDM300SS
UNLOADER	BANJO with return to tank bypass
INLET FILTER	YES
THERMAL PROTECTION VALVE	YES
OIL SIGHTGLASS	YES
CHEMICAL INJECTION	YES
Electric motor	Yes (See voltages above)
BOWSER TANK capacity	150 litres (maximum)
STARTING SYSTEM	Electric Switch
FRAME FINISH	BLACK POWDER COATING
WHEEL	10" PNEUMATIC
HIGH PRESSURE HOSE	10M QUICK RELEASE MSQ DURAKLIX HOSE SYSTEM
GUN AND LANCE KIT	YES - QUICK RELEASE
NOZZLE	5 QR NOZZLES(0 ,25 ,40 AND CHEMICAL)
DIMENSION(CM)	(H)75*(W)68*(L)160cm

IDENTIFICATION DATA

The position of the identification data of the machine

1) Identification of the machine according to EU directives.



ATTENTION:

Check that your TORRENT 2 high pressure washer has been provided with these identification details.

It is obligatory that you ensure that the data label is always attached to the machine and clearly legible.

In case of damage, loss or illegibility, you should submit a written request to the manufacturer who will then provide you with a new one.

IMPORTANT COMPONENTS of your machine

Figure 1:

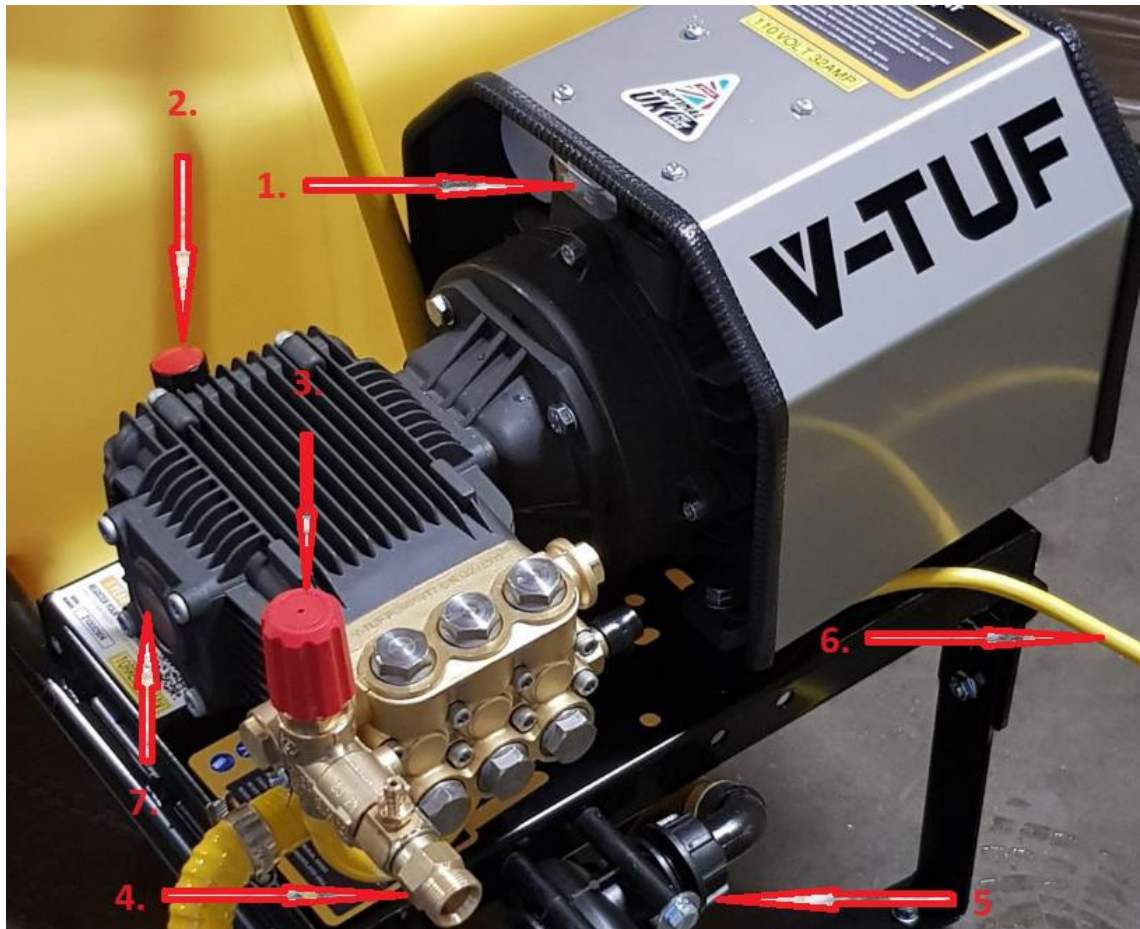

1. **On – off switch:** To start and stop motor pump unit
2. **Oil filler / breather plug**
3. **Pressure adjustment (Factory preset)**
4. **Pump outlet – This is where the high-pressure hose connects**
5. **Main suction filter – Check the filter cartridge daily**
6. **Power cable that has the plug on the end.**
7. **Oil level (max oil level is halfway up the site glass)**

Steps to use your TORRENT2 machine

1. Make sure you are near to the correct electric supply for your machine. (don't use extension cords unless it is the 'Motor Saver' Type)
2. Check all connections are hand tight on the suction filter (Fig1 Pos 5)
3. Fill the tank with clean water through the tank filler (Fig2 Pos 1)
4. Once the tank (Fig2 Pos 3) is full (or at least above ½ full), stand clear of the pump outlet (Fig1 Pos 4) and then turn on the switch (Fig1 Pos 1)
5. Run until you get a strong constant stream of water exiting pump outlet (Fig1 Pos 4) – this is how the pump is initially primed. Then turn off the switch (Fig1 Pos 1)

6. Connect the high-pressure hose, gun and lance (fig 2 Pos 7, 8 , 9) and select the jet of your choice. Make sure all couplings are properly connected so they don't blow apart when they are pressurised.
7. Hold open the trigger for the spray gun (Fig 2 Pos 9) and then turn on the switch (Fig1 Pos 1)
8. Continue the washing task and make sure the tank is always topped up with clean water.
9. When you are not high pressure washing, then turn off the switch (Fig1 Pos 1)

Figure 2:

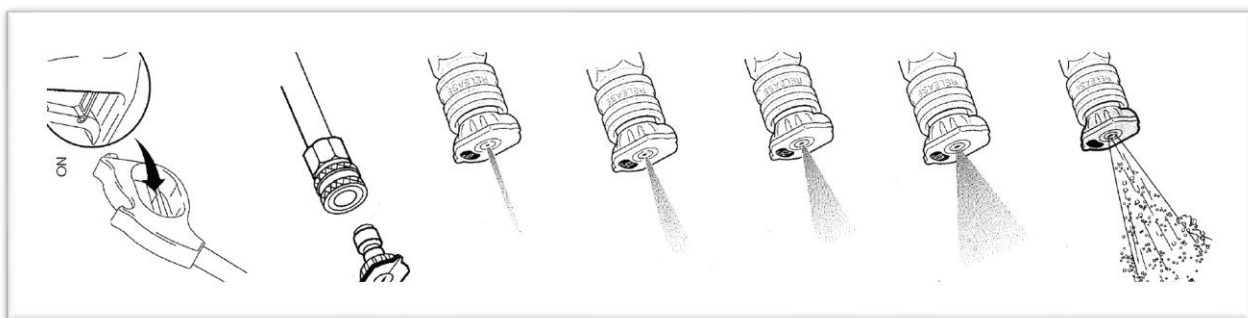

High pressure jets:

To operate the machine, you will need to select a SSQ high pressure jet and then insert it into the end of the spray lance.

Please ensure that you put the safety catch on the ON position as shown in the figure above.

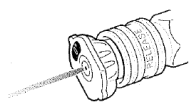

'0' degree (straight spray jet) delivers a pinpoint stream and is extremely powerful. It covers only a small area of cleaning. For a similar effect but a quicker clean you can use a turbo (rotating pin point stream) nozzle see below.



Turbo head (rotating pin point stream Head) – Effectively doubles the cleaning impact of your pressure washer. Known to clean up to 3x faster than standard jets.

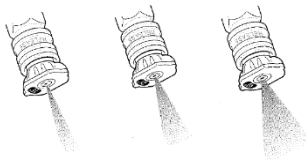

15, 25, 40 degree fan tips giving you a choice of cleaning widths. Please remember: The wider the fan the less the high-pressure water jet impact. But the quicker the coverage.

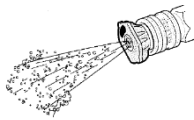

The Chemical nozzle (brass with the biggest orifice) This gives the lowest pressure and will draw chemicals through when used with the chemical injector.

USE WITH CHEMICAL PRODUCTS

With the machine shut down, insert the BLACK soap nozzle into the end of the lance end to obtain the suction and the distribution of the product; pull the gun trigger to obtain the detergent distribution and start the work.



ATTENTION

During operation of the machine, it is obligatory to use the appropriate personal safety equipment.

During operation, please pay close attention to the information quoted on the chemical product labels regarding safety and the proper percentages to be used when diluting chemicals.

Fill the detergent tank (5) with the product you intend to use for your work and insert the detergent hose suction.



Repeat actions 1, 2 and 3 as per cold water use.

During operation, the detergent will be sucked up and automatically mixed with the water.

Practical Advice

Avoid soaking with water the surface you then wish to treat with detergent because, in doing so, you can place a film of water over the area you wish to treat, resulting in poor cleaning results. Instead, whilst holding the nozzle pointing towards the ground, wait until the detergent exits the nozzle. When the detergent exits the nozzle, approach the surface you wish to treat, start from the bottom with overlapping strips until you reach the top of the area, sprinkling the whole area with

detergent. This system is known to avoid dripping of detergent onto dry surfaces, the residue of which could remain even after rinsing.

In order to avoid the formation of deposits or crusts, at the end of operation it is advisable to pass clean water through the pump for a few seconds.

Important Advice

To safeguard the environment, we advise that only authorised detergents are used, that the recommendations of use and dosage are observed on the product labels, that detergent is used sparingly and remember that use of inappropriate detergent, as well as damaging the environment can damage the hot water cleaner as well as the objects being cleaned.

USE DETERGENTS WHICH ARE OVER 90% BIODEGRADABLE.

Before sprinkling detergent over varnished areas with delicate colours, make sure that the surfaces to be treated are not hot, that the detergent has not dried and that the concentration of water / detergent is correct.

IMPORTANT: Rinse well.

Upon completion of operation, shut down the machine then squeeze the pistol lever until the residual water pressure has been expelled.

LUBRICATION OF THE PUMP

For the models 250.15 we recommend:

V-TUF Pressure Lube PL100 – OIL CAPACITY 1.2 litres

For the models 100.12 we recommend:

V-TUF Pressure Lube PL100 – OIL CAPACITY 0.42 kg

You should change the oil after the first 50 hours of use, and after each subsequent 500 hours of operation.

TRANSPORT – LIFTING – SHIFTING

ATTENTION:

Whenever the machine needs to be transported, it should be securely fixed with straps, cables or other suitable equipment in order to avoid accidental movement which could cause damage to people or property as well as to the machine itself.

ATTENTION:

Should the machine need to be lifted, it should be hooked or coupled by means of strips, or suitable lifting equipment which will safeguard the machine's integrity. Make certain that the lifting equipment used has superior capacity to the weight and volume of the machine; the use of equipment conforming to current applicable safety standards is recommended.

ATTENTION:

It is strictly forbidden to remain under or in the immediate vicinity of the machine while it is being lifted or elevated.

Do not trust crushed or bent chains or straps, always use thick working gloves.

Chain or strap fixtures should always be welded in place.

Check that the attachment is sufficiently robust to sustain the weight.

ATTENTION:

Should the machine need to be shifted manually from one place to another, you should ensure that the engine has been turned off, then using the appropriate grip and taking care not to make any sudden movements which could compromise your safety, or that of the integrity of the machine itself, proceed with the moving.

Remember that you must not drag or haul / move the machine over electrical power supply cable or by the high pressure hose. Use the handles built on the machine.

N. B.

For all further things which have not been specified, please abide by general norms for the prevention of injuries.

STORAGE

Park the machine on a flat surface. If the machine is not going to be used for an extended period of time, empty the water circuits and the fuel tank then cover the machine and store it in a place protected from atmospheric extremes.

SCRAP AND DISPOSAL

Should you decide to scrap the machine, we recommend that you render it inoperative using the following procedure: remove from the machine the water supply tubes; cut the power supply cable and tubes; remove the lance and pistol, cut all of the electrical cables, break the pump and the engine, destroy the identification data label of the machine and also those of the pump and engine group.

Please remember that the chemical products contained inside the machines tubing should be removed in advance; if necessary any containers used for this purpose should be recycled or disposed of as per current laws in force.

PACKAGING

The packaging materials should be gathered together and sent to a company specialising in the disposal of refuse (wood, plastic, metal etc.) and not left within reach of children or animals.

ATTENTION

Do not use products containing solvents, methanol or hydrocarbons.

Cleaning Applications

MARKET SECTOR	APPLICATIONS
Automotive	Cleaning Services, such as car washes, and vehicle cleaning in yards like courier's fleet of trucks and vans.
Public Sector	Cleaning outside of hotels and other public eating areas, including car parks, and entrance steps to buildings.
Construction Industry	Cleaning the outside of buildings, concrete & ready-mix centres. Also for cleaning surfaces with hard residue on.
Railway Industry	Cleaning trains & trams. Cleaning railway stations.
Manufacturing Plants	Cleaning up of oil and dirt, and scale that can be known to build up on equipment, floor surfaces; in workshops and mouldings and castings.
Food Industry	Cleaning of food manufacturing plants and equipment on production lines. Built with a stainless steel cover to comply with regulations in these industries.
Fuel & Oil Industry	Cleaning of drilling platforms, cleaning of oil rigs, cleaning of oil trucks, and cleaning of production equipment in oil production facilities.
Airplanes/Ships/Vehicles	Cleaning up of vehicles for public use, and also airstrips and runways and highways that vehicles use.
Logistics / Storage	Cleaning of vehicles, warehouses and transport related industry.
Metallurgy Industry	Cleaning of dirt on equipment that would be used for making products with iron and steel. Can also be used with sand blasting kits to clean hard surfaces such as paints and rusty dirt on steel castings.
Mining Industry	Cleaning of mine vehicles, transportation belts & underground working lines.
National Defence Industry	Cleaning of residue and dirt on and in ammunition depots and vehicles.

Troubleshooting

PROBLEMS	CAUSES	SOLUTIONS
The pump turns but does not reach the required pressure	The pump is sucking in air.	Check that the piping is watertight
	Worn out valves	Replace the valves
	Worn out valve seat	Replace the valve seat
	Worn out or inadequate water nozzle	Replace the water nozzle
	Worn out gaskets	Replace the gaskets
Irregular fluctuations in pressure	Dirty water filter	Clean the water filter
	Worn out suction and/or delivery valves	Replace the valves
	Presence of foreign bodies in the valves which can affect their performance	Check and clean
	Air being sucked in	Check the piping and suction connectors
Drop on pressure	Worn out gaskets	Replace the gaskets
	Worn out suction and/or delivery valves	Replace the valves
	Presence of foreign bodies in the valves which can affect their performance	Check and clean
	Air being sucked in	Check the piping
Worn out gaskets	Replace the gaskets	

<p>Presence of water in the pump oil</p>	<p>Worn out oil seal.</p> <p>High percentage of humidity on the air.</p> <p>Gaskets are completely worn out.</p>	<p>Replace the oil seal.</p> <p>Change the oil twice as often as is normally prescribed.</p> <p>Replace the gaskets.</p>
<p>Excessive noise</p>	<p>Air is being sucked in.</p> <p>Dirty water filter</p> <p>Insufficient water supply.</p> <p>The springs on the suction and/or delivery valves are worn out or broken.</p> <p>Foreign bodies in the suction and/or delivery valves.</p> <p>Worn out ball bearings.</p> <p>The temperature of the water being pumped is excessive.</p>	<p>Check the seals in the tubing.</p> <p>Clean the water filter.</p> <p>Check that the machine has a water supply superior to the flow rate of the pump.</p> <p>Replace the valves.</p> <p>Check and clean the valves.</p> <p>Replace the ball bearings.</p> <p>Lower the temperature of the water being pumped.</p>
<p>Water discharge from between the pump body and the pump head.</p>	<p>Worn out gaskets.</p> <p>Worn out pistons.</p> <p>OR piston plug is worn out.</p>	<p>Replace the gaskets.</p> <p>Replace the pistons.</p> <p>Replace the OR piston plug.</p>

Oil discharge from between the pump body and the pump head.	Worn out oil seals.	Replace the oil seals.
Excessive vibrations.	Worn out or dirty valves.	Replace the valves.
The motor does not start.	A break in the electric supply.	Check fuses or overload, Check that electric socket is on, Check for any cable breaks.

ACCESSORIES PARTS & LIST

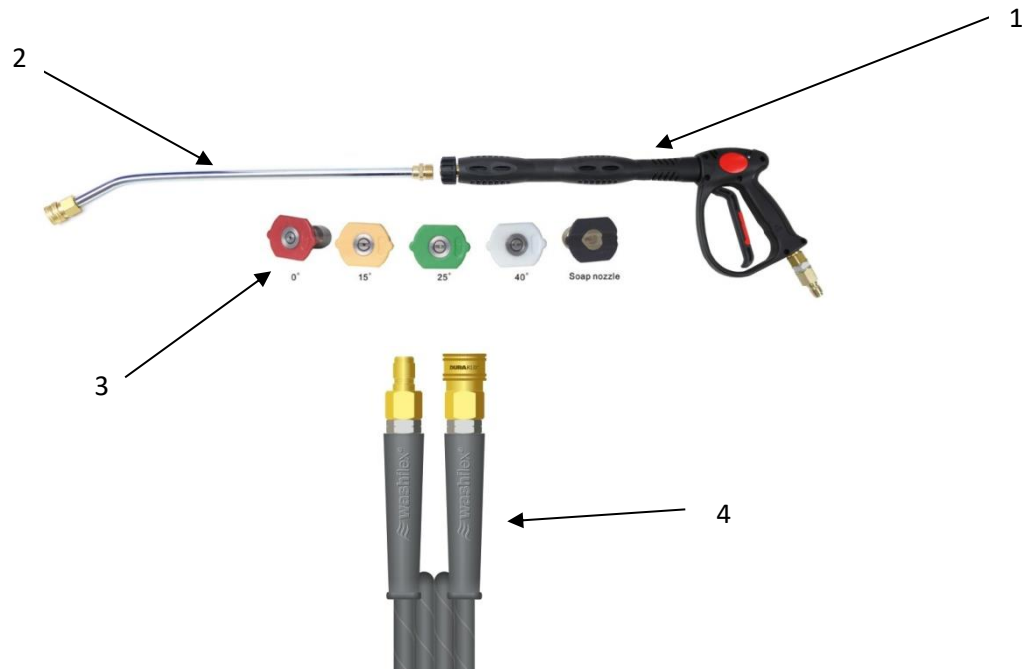

ITEM	CODE	DESCRIPTION	QTY
1	T1.0607QR	QUICK RELEASE 280 BAR TRIGGER AND 1/2" LANCE	1
2	H4.000	500mm LANCE (M22M ~ QUICK RELEASE)	1
3	B14.5000	QUICK RELEASE JET NOZZLES 0, 15, 25, 40 Degree	1
4	WFK151610UVYK	10m HIGH PRESSURE QR HOSE	1

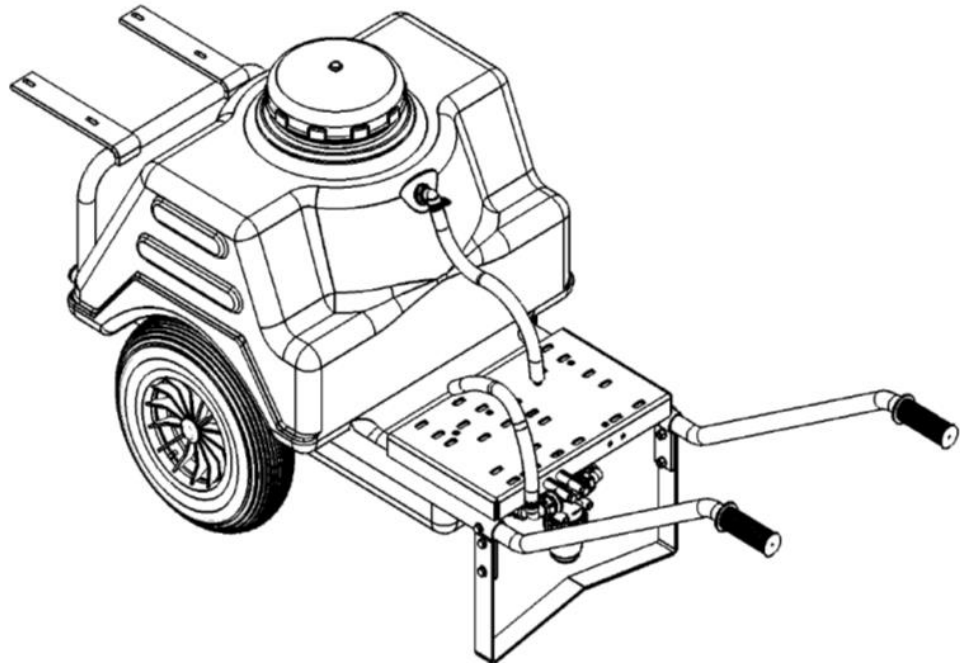

Frame 4 KIT



For more details contact us:

UK Head Office:
+44 (0) 1522 515767

V-TÜF
Fenco House
Unit 5 Chris Sharp Building
Till Bridge Lane
Scampton
LN1 2SX

E-mail: enquiries@v-tuf.com

Web: www.v-tuf.com

Follow us:

